

PRODUCT MANUAL

MADE IN

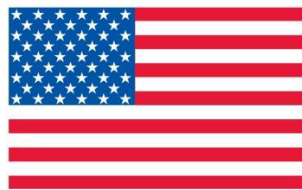

U. S. A.

THIS MANUAL PROVIDES THE MANUFACTURER'S RECOMMENDED USE OF THE PRODUCT. IT IS NOT INTENDED TO BE AN ALL INCLUSIVE GRAIN ENTRAPMENT RESCUE GUIDE.

REVIEW EMERGENCY ACTION PLANS, OSHA CONFINED SPACE ENTRY PROCEDURES, AND UNDERGO TRAINING ON CURRENT GRAIN ENTRAPMENT RESCUE PROCEDURES IN ORDER TO BE FULLY PREPARED FOR GRAIN RESCUE SITUATIONS.

ABOUT OUR PRODUCT

The Great Wall of Rescue was created to be an asset in any grain extrication procedure. When used correctly, the Great Wall will increase the likelihood of a successful rescue. The design has proven to be more effective, more favorable, and more user-friendly than other rescue tubes in trial runs, training drills, and real grain rescues and recoveries.



The Great Wall of Rescue outshines other rescue products in terms of design and implementation. The Wall is devised so that it can be used in various configurations in order to adapt to a multitude of rescue scenarios from stored, free-flowing grain. The individual panels can be aligned to form a wall, a tube, and/or other irregular shapes depending on the rescue situation and the number of panels the rescuers can access.

Made of lightweight aluminum, rescuers can easily lift a panel up and join with another. The sleek finish allows the panels to slide easily into grain. Anodized ball/socket joints promote smooth and easy panel connection and are resistant to jamming. The ball/socket joint was specifically designed so that the panels have some range of movement, adding variability to the possible shapes. The bends in the panels along with hinge that runs the entire length of the panel gives the panel added strength and will not cave in on the victim. When the panels are inserted into the grain mass, the grain is removed from around the victim to relieve pressure.

The Great Wall should be assembled by two or a maximum of three trained first-responders. It is not recommended that more than 3 rescuers assist with the installation of the Great Wall in order to avoid complications that may arise (increased pressure on the victim, grain shifting, possible entrapment of rescue workers, etc.)

INSTRUCTIONS FOR USE

01 INSPECTION

Inspect Great Wall of Rescue panels for flaws or defects that may jeopardize performance.

02 ASSESS THE SITUATION

Identify obstacles that may affect installation of Great Wall panels. Determine how many panels are needed to surround victim. If victim is unconscious, consider building a large configuration so a rescuer can bail grain or give medical attention from the inside. Locate victim's extremities before inserting panels to avoid injury.

AFTER DEVISING A RESCUE STRATEGY, PANEL INSERTION CAN BEGIN.

Note: Keep the Great Wall panels from binding in the hinge, as shown in Object 1. Binding makes pressing wall panels more difficult.

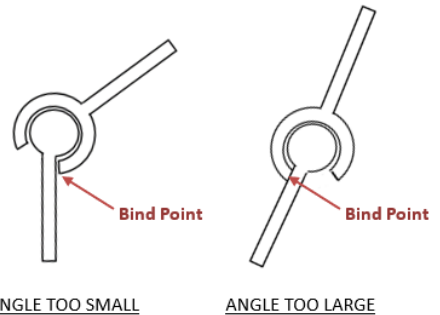
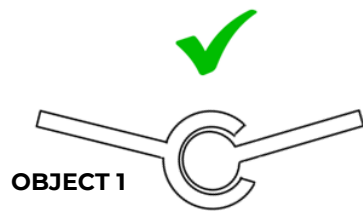

03 BEGIN PLACING PANELS

Place first panel in front of victim to divert shifting grain away from his face. Using step or hands, press first panel down 12" - 24" into grain. One rescuer holds first panel steady while another rescuer lifts second panel up to make a ball/socket connection with first panel. Do not let the panels "free-fall" into the grain. Press second panel down to 12". Continue this process until remaining panels are connected in desired configuration and about a foot in grain.

Take a moment to straighten panels vertically and check hinges for binding. We find that it helps to "shake" them to straighten them out.

04 INSERTING PANELS

Hook the step onto top middle section of the panel directly in front of victim. Place your foot on step and use body weight to press panel down.

Note: The step has two spots to hook on panel; a lip at top and a lip midway down. When all panels are pushed down to three feet, move step to middle lip for more clearance.

continued on next page..



INSTRUCTIONS - PAGE 2

Continue pressing alternating panels into grain, one at a time, across from each other, in 12" to 18" increments. This back and forth strategy helps the tube go in straight and evenly. Object 2 depicts the suggested pattern to pressing in panels.

It will take more effort to press panels into grain as they get deeper due to the grain load "squeezing" panels together.

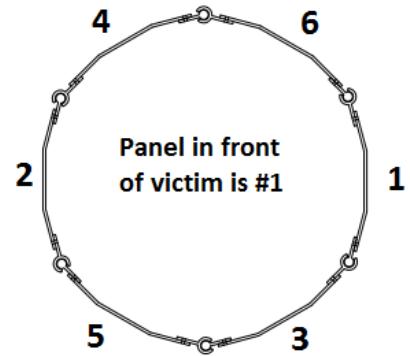

OBJECT 2

05 BAILING GRAIN

Continue bailing grain and pressing panels down until victim is freed. The panels can be pressed up to 4'8" into the grain. Do not remove grain from below the handholds in the bottom of the panel; this helps maintain structural integrity of the configuration. Grain may flow in through the bottom handhold; this minuscule amount will not hinder rescue efforts.

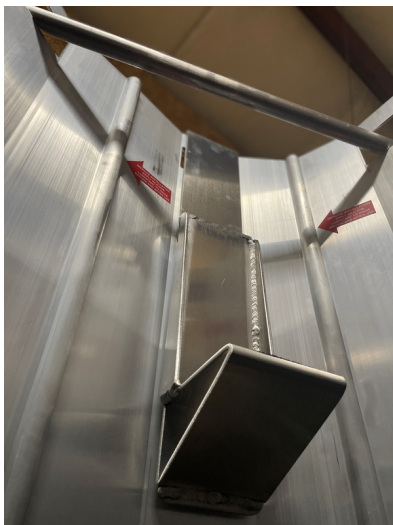

When enough grain is removed from around the victim so that he is freed from grain, a step may be placed inside of the rescue tube to help a conscious victim climb out or rescuer climb in.

06 REMOVAL

When rescue is finished, panels can be removed using removal pipe. Place pipe through handhold of one panel and use as lever to pry panels up. Use caution when pulling panels out; rescuers may lose footing when grain flows back inside tube to fill the void.



CONFIGURATIONS

The Great Wall of Rescue can adapt to your specific rescue situation with these different configurations:

ROUND TUBE

Arrange EACH panel so that the red label is on the side of the panel that faces AWAY from the victim. This will align the curves of the panels in a way that begins to form a circle around the victim. A larger tube can be formed by simply adding panels.

7 Panel Tube - 3 Foot Diameter

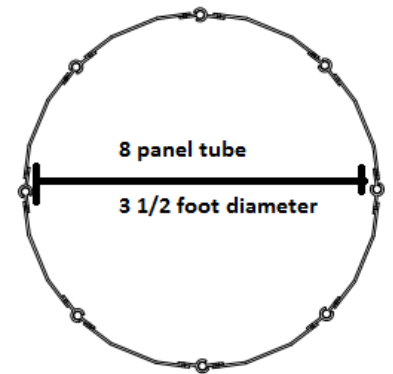
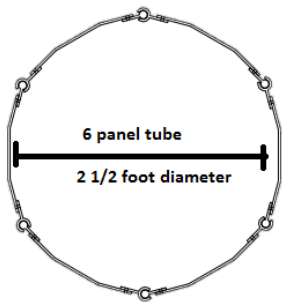

CURVED WALL

Ideal for situations in which the victim is trapped near an obstacle or edge of bin wall. A curved wall can be utilized when rescuers are unable to form a complete tube do to a bin wall or obstacle, and will still reduce the pressure of grain on victim and prevent further entrapment from flowing grain.

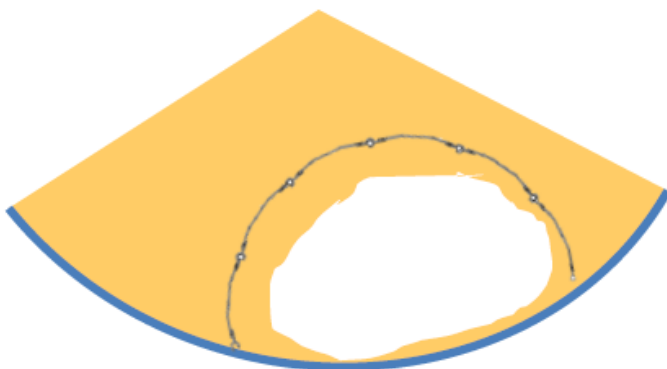

CONFIGURATIONS - PAGE 2

STRAIGHT WALL

Arrange the panels so that EVERY OTHER panel has the label at the top on the side facing away from the victim; the other panels should have the label at the BOTTOM and on the side facing TOWARDS the victim. This configuration ensures that the angles will alternate direction, leading to a straight wall.



BARRIER WALL

If there is access to enough panels, a rescue tube can be formed around the victim, and a curved wall can be formed around the rescue workers, acting as a barrier to divert flowing grain. Use one set of Great Wall panels to form a complete tube around the victim, then place another set of panels in a curved wall configuration surrounding the rescuers, tube, and victim. Be sure that the barrier wall “curves” downhill, so that it diverts the flow of grain out and around, as opposed to catching it.

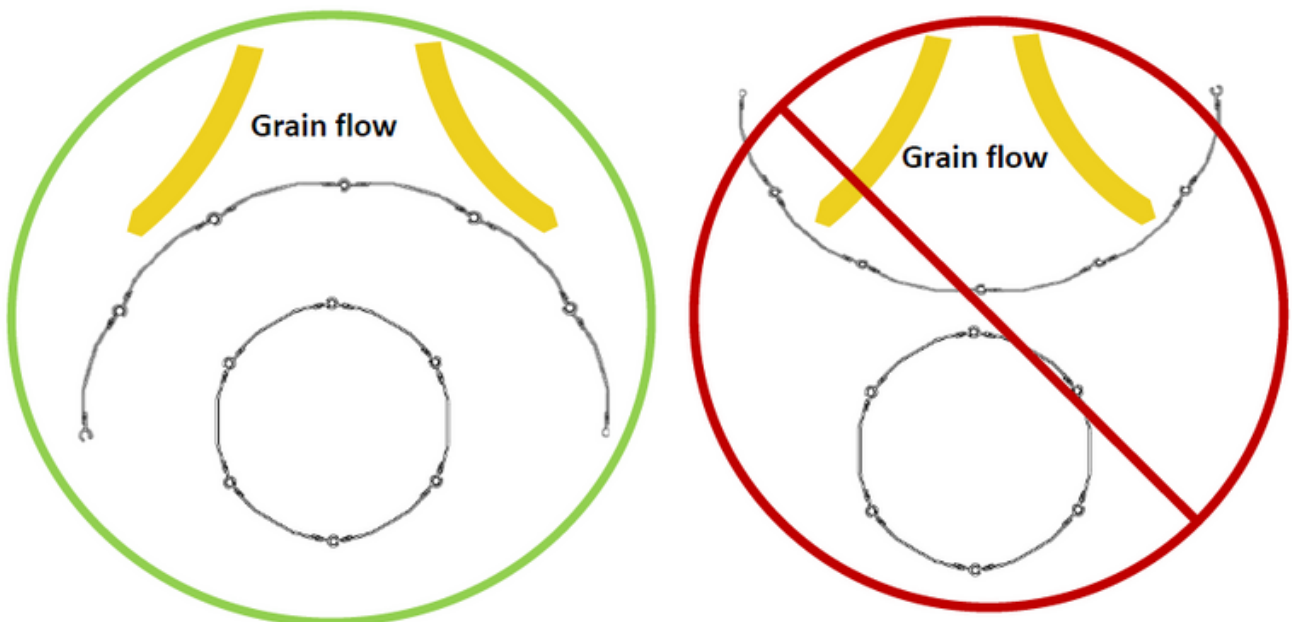

CARE

INSTRUCTIONS



- TRAIN WITH YOUR GREAT WALL SET!**
Frequent use will smooth down milled edges and hinges will slide easier.
- Keep hinges lubricated with thin oil. A quick spray of silicone down in the inside of the socket channel "C" before each use will aid in smooth connections. Wipe out the socket and re-spray before packing into case. We do not recommend using a lithium base lubricant due to build up.
- Store Great Wall panels in a clean environment to prevent dust build up on lubricated sockets.
- Package panels neatly in carrying case. Panels will snap together when stacked, face up, in alternating directions. Rescuer platforms and pipe fit snugly on the sides of the case. Hook step on top panel, face up. Use interior straps to tightly bind everything inside of the case.
- Great Wall systems packed in the carrying can be stored lying flat, or stood up on end and secured to a wall.
- If panels that are not stored in carrying case, they should be stacked neatly and secured to avoid denting and bending.

ACCESSORIES



CARRYING CASE

Up to eight Great Wall panels can be stored neatly in our heavy duty carrying case. Interior straps tightly bind all accessories. Handles make it easy to transport a packed case. A packed carrying case can be stored laying down, or securely strapped upright.



STEP



PIPE

This 3 foot long pipe can be put through the hand holds to serve as a handle for the victim. The pipe also serves as a pry-bar to remove panels from grain after a rescue or training.



The step was specially designed to be a safe and easy way to advance individual panels into the grain. Rescuers simply hook the step onto the flat, middle section of a panel, and step or press to push panels into grain. Step may be switched to the inside for victim to climb out.

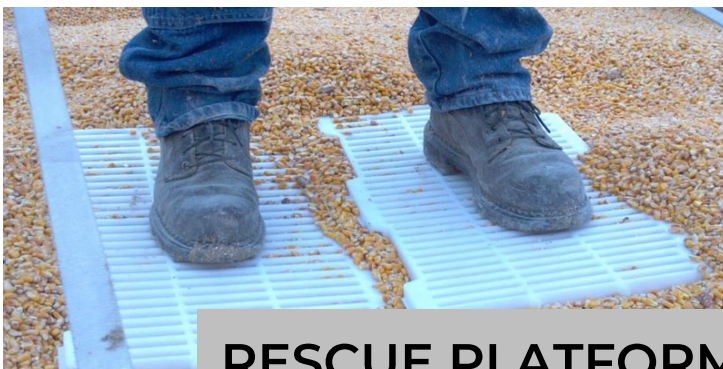

RESCUE PLATFORMS

The 12" x 24" poly platforms will distribute a rescuers weight, making it easier to walk in grain, lessen the chance of grain movement, and reduce pressure of body weight felt by victim.

TABULATED DATA

GREAT WALL OF RESCUE MODEL#4 TABULATED DATA as supplied by Dunright, LLC.

| Material | Bulk Density (pcf) | Active Pressure @ 5' deep (cone down) (psf) | Factor of Safety @ 5' deep (cone down) | Active Pressure @ 10' deep (cone down) (psf) | Factor of Safety @ 10' deep (cone down) | Active Pressure @ 15' deep (cone down) (psf) | Factor of Safety @ 15' deep (cone down) |
|----------|-----------------------|--|--|---|---|---|---|
| Alfalfa | 48 | 184 | 11.7 | 367 | 5.8 | 551 | 3.9 |
| Barley | 39 | 165 | 13.0 | 330 | 6.5 | 496 | 4.3 |
| Canola | 43 | 185 | 11.6 | 370 | 5.8 | 554 | 3.9 |
| Clover | 48 | 187 | 11.5 | 374 | 5.7 | 561 | 3.8 |
| Corn | 45 | 196 | 11.0 | 392 | 5.5 | 588 | 3.7 |
| Flax | 45 | 196 | 11.0 | 392 | 5.5 | 588 | 3.7 |
| Grass | 14 | 45 | 48.1 | 89 | 24.1 | 134 | 16.0 |
| Millet | 40 | 167 | 12.9 | 334 | 6.4 | 501 | 4.3 |
| Oats | 35 | 153 | 14.1 | 305 | 7.0 | 458 | 4.7 |
| Rye | 45 | 191 | 11.3 | 381 | 5.6 | 572 | 3.8 |
| Sorghum | 45 | 169 | 12.7 | 338 | 6.4 | 506 | 4.2 |
| Soybeans | 48 | 209 | 10.3 | 418 | 5.1 | 628 | 3.4 |
| Wheat | 48 | 187 | 11.5 | 374 | 5.7 | 561 | 3.8 |

Chart Notes:

1. This tabulated data sheet is to be used with the Great Wall of Rescue Model #4, as supplied by Dunright, LLC.
2. Tabulated data sheet has been prepared by a licensed structural engineer using principles of engineering mechanics.
3. Maximum depths are those representing the grain loads that these depths would present on the panels. Depths over 5 feet may be reached by placing a smaller diameter cofferdam inside the space created by a larger cofferdam.
4. Factors of safety are based on bending yield stress of 35 ksi for 6005-T5 Aluminum.
5. Factor of safety is defined as "the ratio of the ultimate breaking strength of a member or piece of equipment to the actual working stress or safe load when in use". - OSHA Standards 29 CFR Part 1926 Definitions.
6. The depth indicated in the table above measures from the surface of the grain at cofferdam placement, straight down to the bottom of the cofferdam.
7. Great Wall of Rescue panels must only be combined with other Great Wall of Rescue panels.
8. The grain type indicated represents those grains commonly used and not atypical type or condition.
9. Panels must be inspected before each use and may not be modified from their original state, unless approved by Dunright, LLC.
10. Mechanical equipment should not be used to force panels into or out of grain. Mechanical equipment may alter panel integrity.
11. All other recommendations by the manufacturer must be followed.
12. The cofferdam must not be used in grain flowing due to grain unloading equipment.
13. Dunright, LLC assumes no responsibility for the success of any rescue operation using the Great Wall of Rescue.
14. The Great Wall of Rescue should only be used by trained, competent personnel. Follow all OSHA procedures including confined space entry procedures where applicable.
15. Seek the advice of manufacturer if any procedures or specifications are not clearly understood.



Signature [Handwritten Signature]
 Date 4/19/23
 Exp. Date 11/30/24